

**ONA** WE  
ARE  
EDM

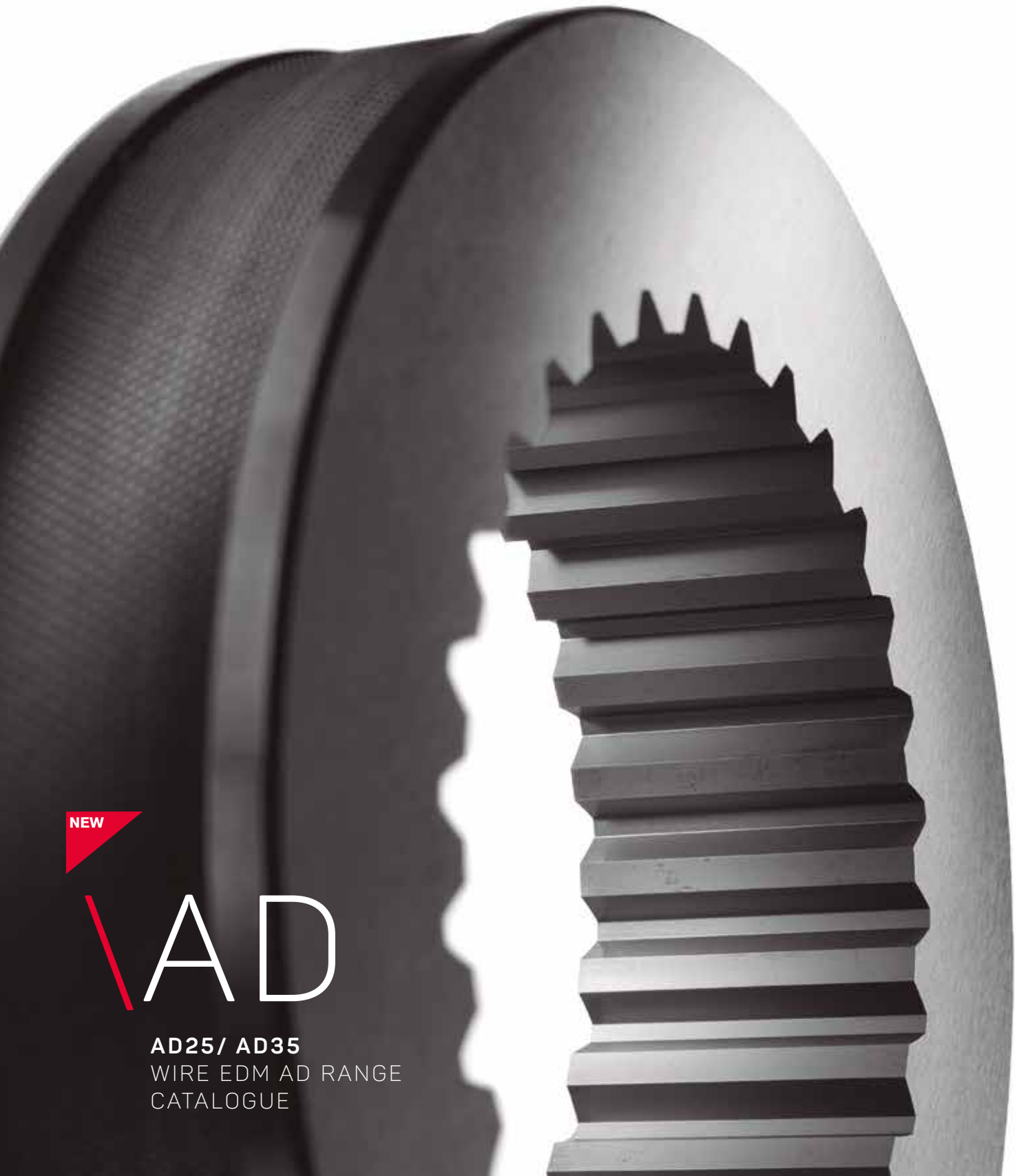

**NEW**

**AD**

**AD25/ AD35**  
WIRE EDM AD RANGE  
CATALOGUE

ONA, WE ARE EDM

# KNOWLEDGE AND EXPERIENCE

at the client's service.

At **ONA** we are pioneers in EDM technology. Our over **65 years of history** have made us the most specialised manufacturer in the world. With ONA, the client is guaranteed a highly qualified team, experts in the manufacture of EDM machines and precision assemblies. A history full of technological advances and improvements with over **15000 machines installed** all over the world. We are present in 60 countries thanks to a wide network of **distributors around the world ensuring fast and efficient service at any time.**

Our long experience makes us a reference in EDM in the most competitive industrial sectors:



AUTOMOTIVE ENERGY AEROSPACE MOULD AERONAUTICS

over 65 years of history

over 15000 machines installed

present in more than 60 countries

## INDEX

\ MACHINE PRESENTATION	04
\ CONTROL	06
\ GENERATOR	08
\ MECHANICS	10
\ SERVICE AND EXPERT ADVICE	12
\ TECHNICAL SPECIFICATIONS	14



MACHINE PRESENTATION

# PROFITABILITY AND PRECISION AT AN AFFORDABLE PRICE



AD25

## HIGH PRODUCTIVITY

An affordable machine that guarantees maximum productivity in precision work.

## RELIABILITY

Moreover, the **ONA AD25** guarantees a reliability in the erosion of parts.

## TECHNOLOGICAL TABLES FOR PRECISION CUTTING

The **ONA AD25** machine includes technological tables especially designed for precision cutting. Using tables, the operator can be sure of the levels of precision in wire EDM.

## WINDOWS-LIKE INTERFACE

The windows-like graphical interface makes life easy for the operator, while providing a automation capability.

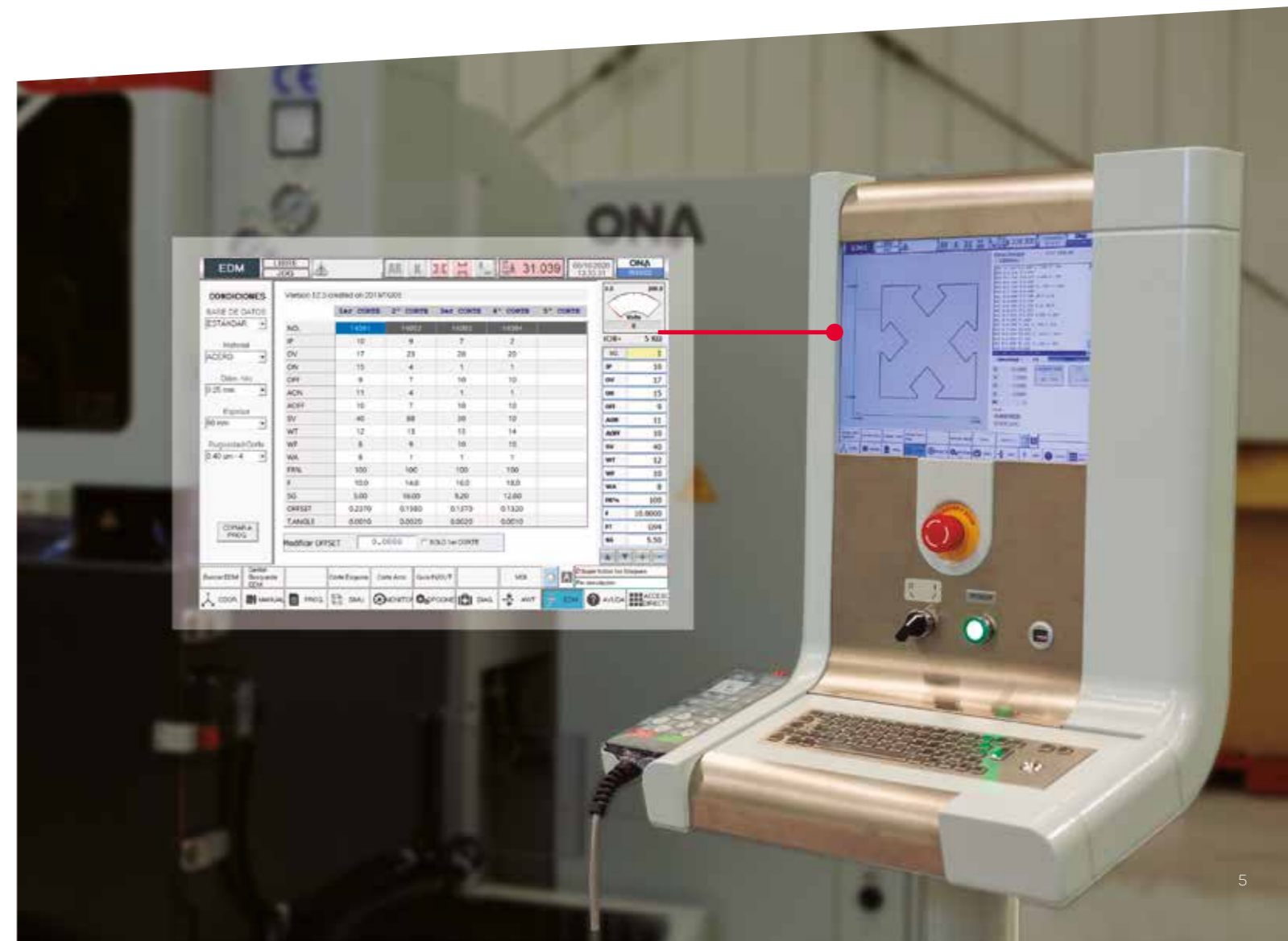
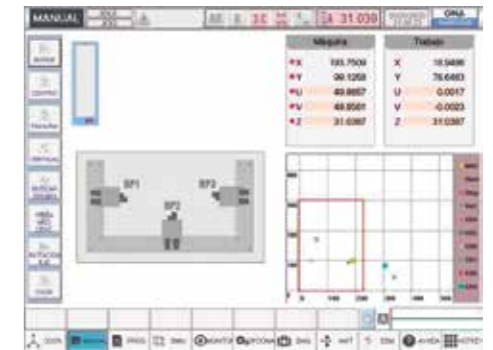

CONTROL

# QUICK AND EASY OPERATION

A simple effective tool for programming

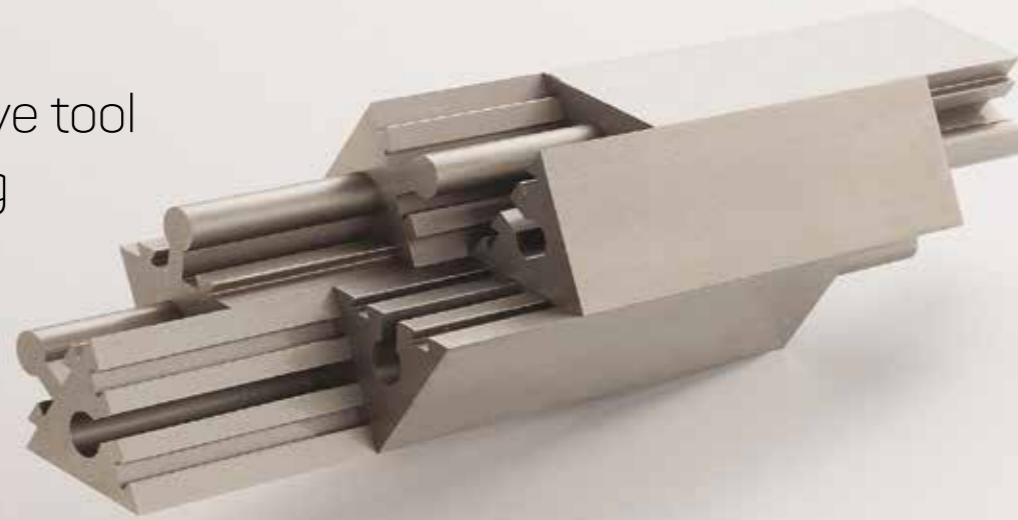

## CERTIFIED ACCURACY

Each machine is laser-tested according to the VDI 3441 (axes positioning) and ISO 230-4 (circularity) standards.

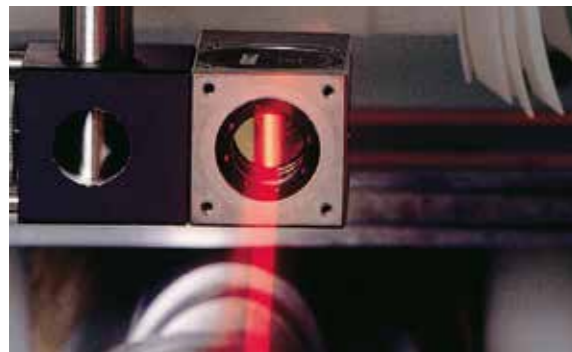

## PROGRAMMABLE CONTROL OF THE Z AXIS

CNC control of the Z axis is standard on all ONA AD25 machines. It is very useful in the cutting of workpieces of various heights, since the Z positioning and the correspondent cutting strategy can be programmed.

## 5 AXES CONTROLLED

All ONA **AD25** machines can control up to 5 axes simultaneously.

## CORNER CONTROL

According to different cutting data, wire diameter, angle and workpiece thickness, the control automatically optimizes parameters to maintain the best corner cutting performance with accuracy, as well as cutting speed. Even on the small and continuous corners, ONA still can meet corner accuracy.

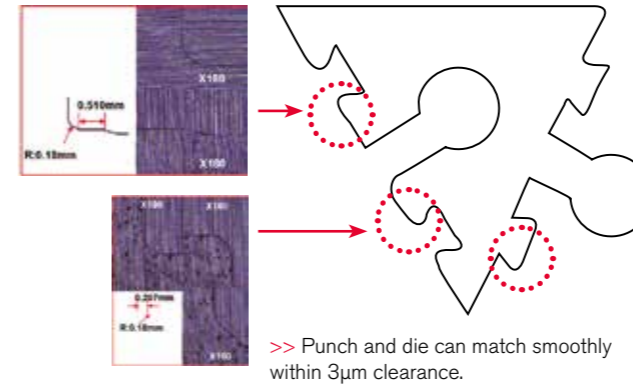

## CORNERS AND CIRCLES

Precision at the critical points of the workpiece (corners and circles) is increased thanks to new compensation algorithms and to the control of the lateral discharge during reruns. The new generator was designed to maintain precision at these points where change in direction is critical and the optimisation of braking ramps helps prevent losing time on the curves.



## JUMP function:

if a workpiece cannot be realized, the machine moves on to the next

## Threading in flushing mode:

1. Automatic recovery of during immersion erosion point following power failure
2. Control of corners and rounding. Optimized strategies for roughing and finishing.

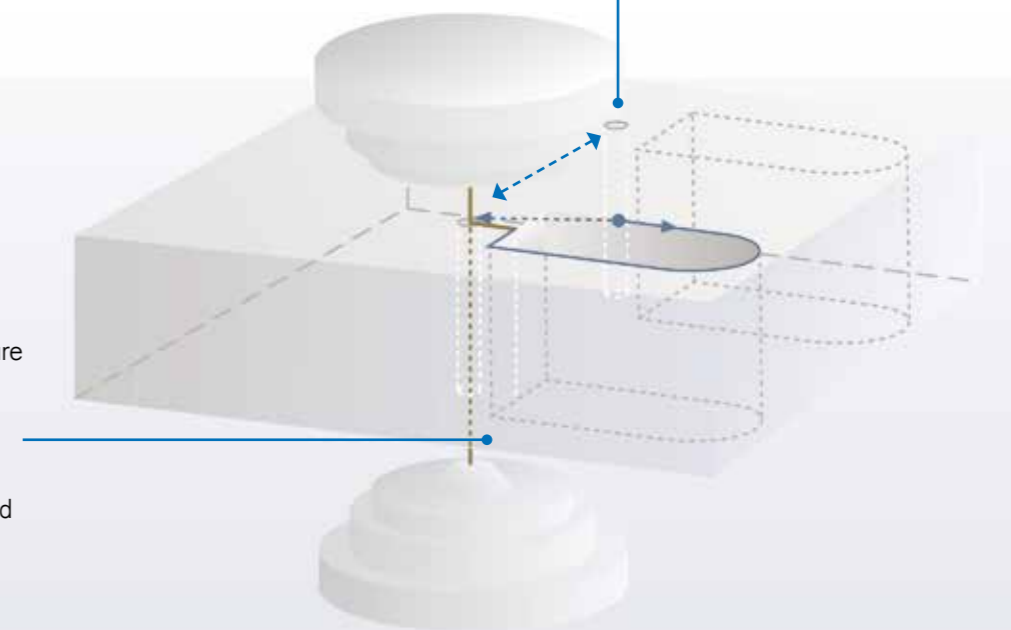

GENERATOR

# RELIABILITY



## \ PRODUCTIVITY AND SURFACE FINISH

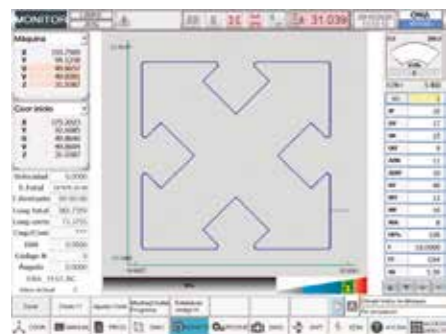

- Material: steel
- Punch thickness: 100 mm - 4 inches
- Wire type: uncoated brass of diam. 0.25 mm - 0.010 inches.
- Number of cuts: 1 cut and 1 skim cuts
- Vertically precision 2 µm/side



## \ PRECISION TAPER CUTTING

An automatic system is built into the CNC for compensating the deflection point of the wire in the guides. This ensures precision in taper cuts and simplifies the job for the operator.

Tapered workpieces, even those with a geometry entailing various taper angles, can be handled automatically and with high precision.



## \ EXPERT EROSION SYSTEM

The expert erosion system allows for an effective control of the cutting process, automatically modifying the programmed parameters of the power supply, ensuring optimum machine performance at each stage.

The expert erosion system is of special importance when cutting complex pieces, as staggered pieces, pieces with wide angles of taper cut, etc.

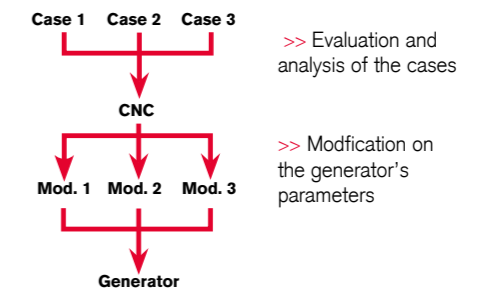
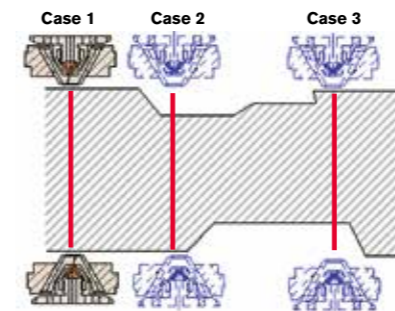

## \ ACCURATE REPEATABILITY

Repeatability in accuracy by applying the same cutting data on different machines, the consistence enhances the quality of workpiece and simplifies management procedure.



MECHANICS

# MECHANICAL STRUCTURE THAT ASSURES A LASTING ACCURACY

ONA, robustness and reliability since 1952

## MECHANICAL STRUCTURE . T-BASE CONSTRUCTION

The longer X-axis is located on the base. The shorter Y-axis is located on top of X-axis.

## COLLISION PROTECTION SYSTEM

All machines feature as standard a collision protection system

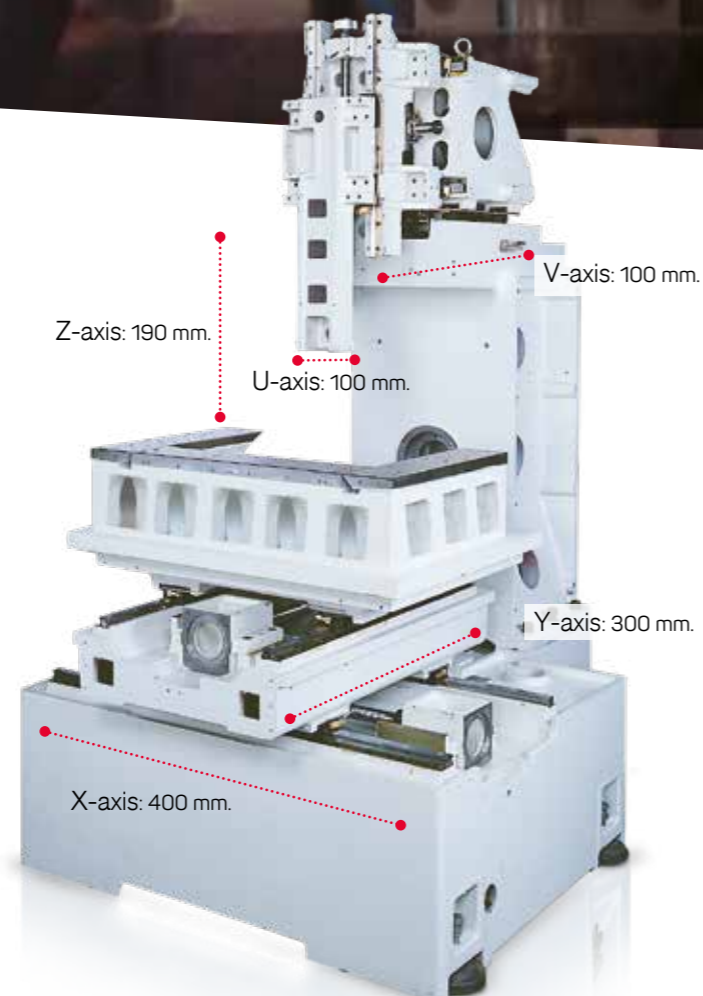

## DIRECT CONTROL POSITIONING

High precision glass scales are used in all ONA AD25 machines.



## NEW GENERATION SHAFT LINEAR MOTOR

Lower maintenance cost. Excellent low power consumption characteristics.



## HIGH REALIABLE AUTOMATIC THREADING

- The maximum height for threading is equal to the maximum travel on the Z axis.
- Minimal maintenance required due to wear-resistant elements and optimized design.
- Minimum threading hole diameter: 0.5mm (0.02 inches)

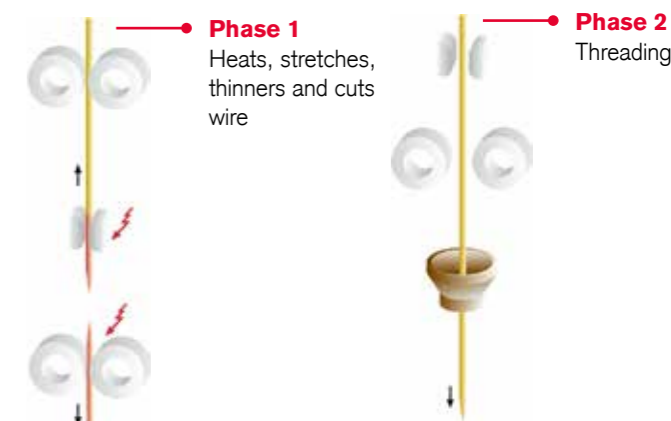

SERVICE AND EXPERT ADVICE

# TOTAL AVAILABILITY

At any time and anywhere in the world

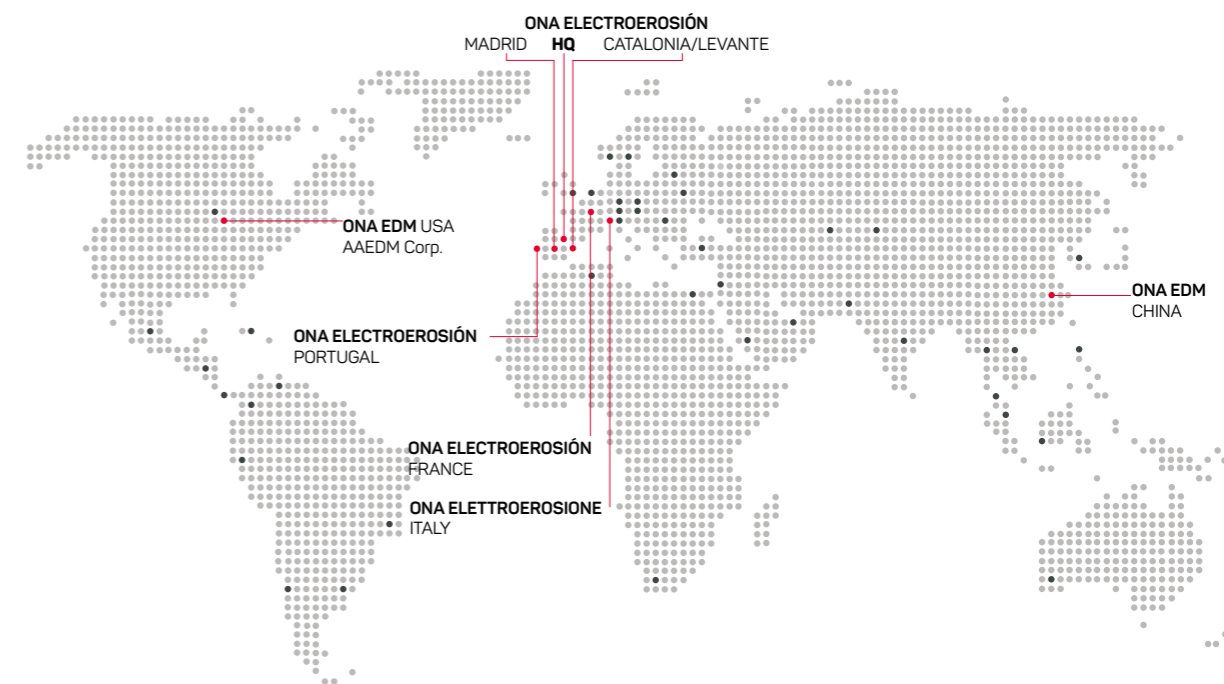

## LOCAL SERVICE TEAM

ONA places a network of local service points at the disposal of our clients with highly qualified native personnel for delivering quick and customised service which is tailored to the clients.

## OWN EXPERT SERVICE

At ONA, we are committed to developing our own machines, CNC, generator and technology included. Our team of experts ensure that we are able to manage our clients' demands directly.

## KNOWLEDGE AT CLIENT'S SERVICE

We have an **excellence centre** in our plant where all the machines are subjected to **performance tests** to guarantee **compliance with each and every one of the client's demands**. It is only after all the tests have been passed and the production process ordered by the client has been verified is the machine deployed and commissioned on their premises.

## APPLICATION ENGINEERING

We place the knowledge and experience of our team of experts at the disposal of our clients **to optimise the different key parameters** of the manufacturing processes. We work together with the client to develop **alternative work flows** to help make the most of each application



## TRAINING

**Committed to the training of future experts in the sector.**

We have developed a training programme, offering basic instruction and more advanced training, in order to bring EDM closer to each client and make the processes both intuitive and simple. These training sessions can take place at ONA premises or at the client's own premises in other parts of the world.



## APPROVED CONSUMABLES

**ONA guarantee with each consumable.**

We have always been in favour of using approved top-quality consumable products and original replacement parts. Their use guarantees optimum production and prolongs the useful life of each piece of equipment while optimising costs. In addition, it ensures maximum efficiency and the best results.

## TECHNICAL SPECIFICATIONS



### SPECIFICATIONS

	ONA AD25		ONA AD35	
	mm / Kgs	in (") / lb	mm / Kgs	in (") / lb
Max. Workpiece dimension	790 x 560 x 190 mm	31.1 x 22 x 7.4 in	990 x 620 x 290 mm	38.9 x 24.4 x 11.4 in
Max. Workpiece weight	700 kgs	1543 lb	1000 kgs	2204 lb
Max. Workpiece height	190 mm	7.4 in	290 mm	11.41 in
X/Y axis traveling	400 / 300 mm	15.7 / 11.8 in	600 / 400 mm	23.6 / 15.7 in
U / V axis traveling	100 / 100 mm	3.9 / 3.9 in	100 / 100 mm	3.9 / 3.9 in
Z axis traveling	190 mm	7.4 in	290 mm	11.41 in
Wire size range	0.2, 0.25, 0.30 mm	0.007, 0.009, 1.1 in	0.2, 0.25, 0.30 mm	0.007, 0.009, 1.1 in
AWT function	Standard	Standard	Standard	Standard
Anticollision function	Standard	Standard	Standard	Standard
Wire spool	16 Kgs	35.27 lb	16 Kgs	35.27 lb
Working table	U Shape	U Shape	U Shape	U Shape
Max. Tapper	±21° / 100 mm	±21° / 3.93 in	±21° / 100mm	±21° / 3.93 in
Machine power consumption	15 KVA	15 KVA	15 KVA	15 KVA
Max. Axes speed	800 mm/min	31.49 in/min	800 mm/min	31.49 in/min
Wire guide type	Closed type	Closed type	Closed type	Closed type
Autolubrication system for X and Y axis	YES	YES	YES	YES
Linear Motors X and Y axis	YES	YES	YES	YES
Glass scales resolution on X and Y axis	0.1 µm	0.1 µm	0.1 µm	0.1 µm
Encoder in U, V and Z axis	0.1 µm	0.1 µm	0.1 µm	0.1 µm
Best Roughness	0.4 Ra	0.4 Ra	0.4 Ra	0.4 Ra
Filter	Cartridges	Cartridges	Cartridges	Cartridges
Filtering quality	3 µm	3 µm	3 µm	3 µm
Cutting technology	Flushing and submerged	Flushing and submerged	Flushing and submerged	Flushing and submerged

### DIMENSIONS

	ONA AD25		ONA AD35	
	mm / Kgs	in (") / lb	mm / Kgs	in (") / lb
Foot print W x D x H	2980 x 3000 x 2063 mm	117.3 x 118.1 x 81.2 in	3440 x 3140 x 2210 mm	135.4 x 123.6 x 87 in
Total machine weight	3000 kgs	6614 lb	3700 kgs	8157 lb
Water capacity	850 Litres	850 Litres	850 Litres	850 Litres
Resin capacity	14.4 Litres	14.4 Litres	14.4 Litres	14.4 Litres

## Dimensions

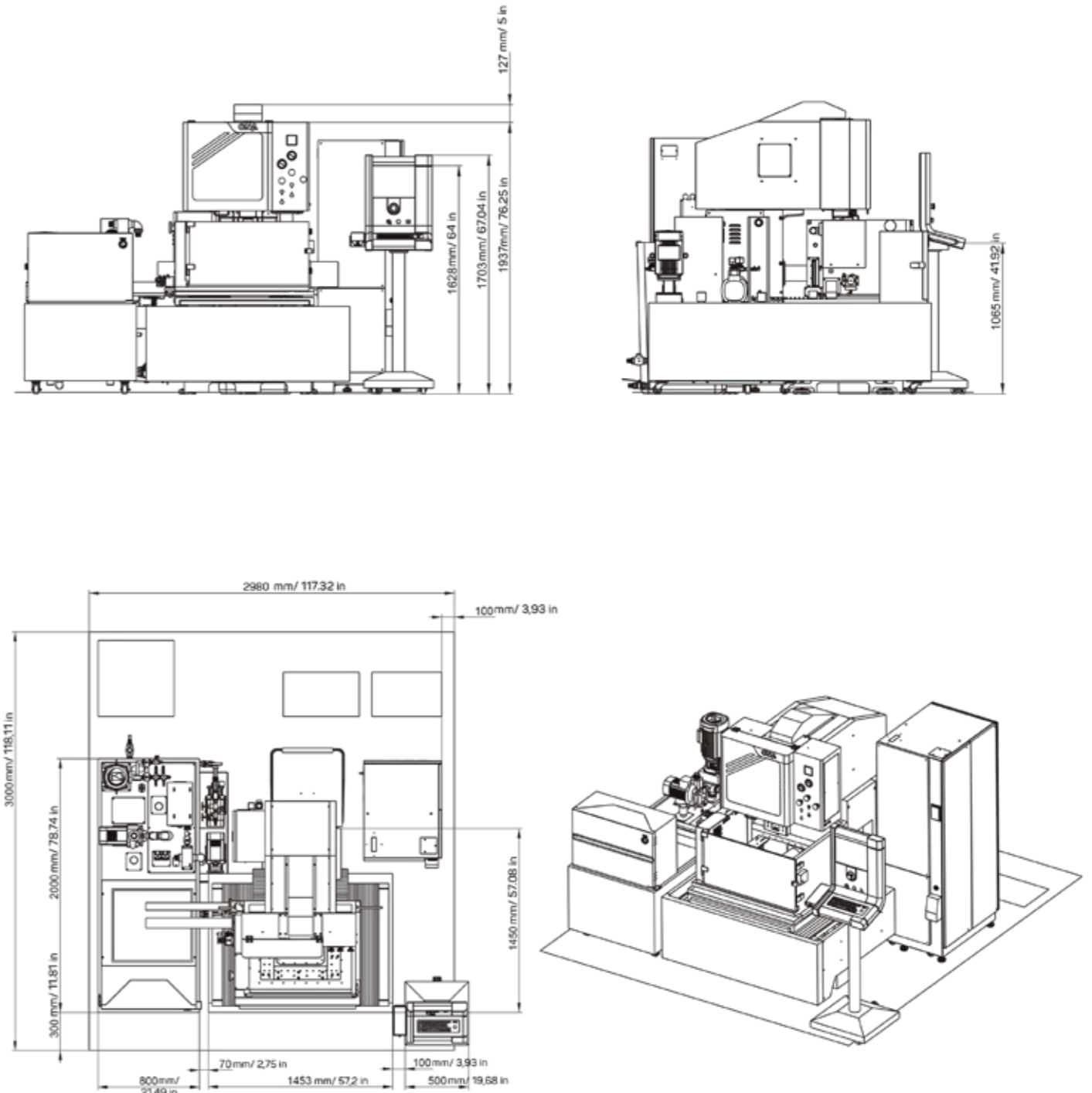

# We are at your service anytime and anywhere in the world

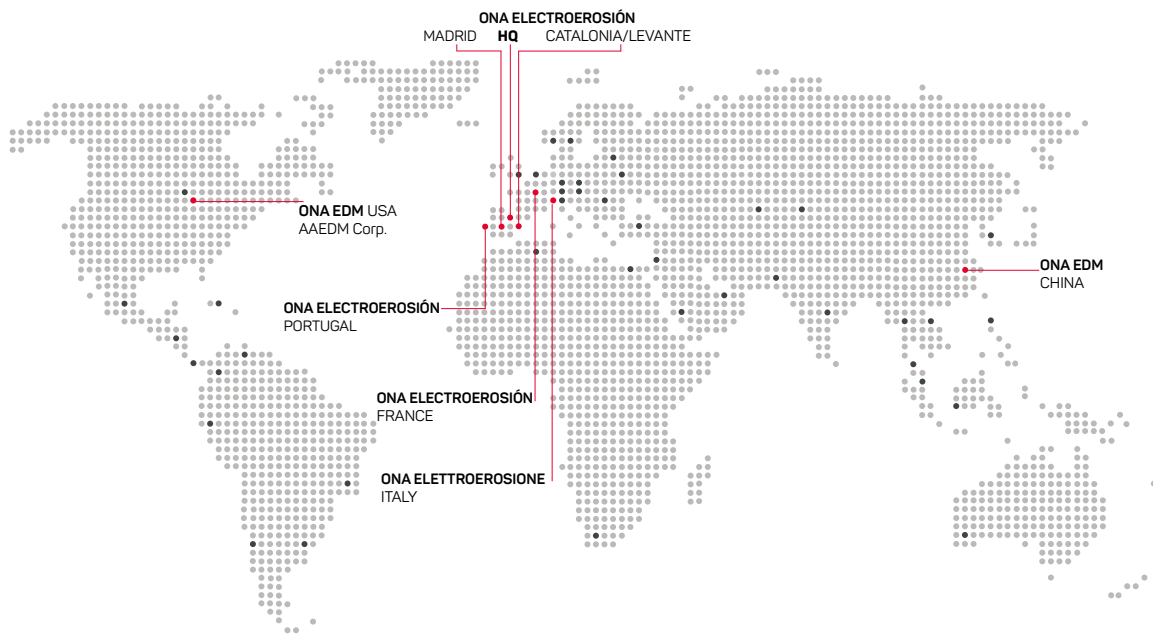

Copyright © 2021 ONA ELECTROEROSION, SA. All rights reserved. Reproduction or modification of this catalogue is strictly prohibited without prior written permission.

**ONA ELECTROEROSIÓN  
(central)**

Eguzkitza, 1  
48200 Durango  
Spain  
\[ona@onaedm.com](mailto:ona@onaedm.com)

**ONA EDM USA, INC.**

7455 Newman Blvd  
Dexter, Mi. 48130  
USA  
\[service@onaedmusa.com](mailto:service@onaedmusa.com)  
\[onausa@onaedm.com](mailto:onausa@onaedm.com)

**ONA ELETTREROSIONE S.R.L**

Via M. D'Antona 59/61  
10040 Rivalta di Torino (TO)  
Italy  
\[onaitalia@onaedm.com](mailto:onaitalia@onaedm.com)

**ONA ELECTRO-EROSION, LDA.**

C. Emp. Vilar do Pinheiro  
Via José Regio (EN 13)  
Fracção 1- N° 388  
4485-860 Vilar do Pinheiro  
Portugal  
\[onaportugal@onaedm.com](mailto:onaportugal@onaedm.com)

**ONA ELECTRO-EROSION,  
S.A.R.L.**

20 rue Salvador Allende  
I. Molina / La Chazotte  
42350 La Talaudiere  
France  
\[onafrance@onaedm.com](mailto:onafrance@onaedm.com)

**ONA EDM Machine Tool  
(Shenzhen) Co. Ltd.**

Room 108B, Building 8, Phase  
II, Nanshan Yungu Innovation  
Industrial Park,  
Nanshan District, Shenzhen  
Guangdong 518000  
China  
\[onachina@onaedm.com](mailto:onachina@onaedm.com)

☎ (+34) 946 200 800

✉ [ona@onaedm.com](mailto:ona@onaedm.com)

\[www.onaedm.com](http://www.onaedm.com)